

INSTALLATION GUIDE

(all dimensions are mm)

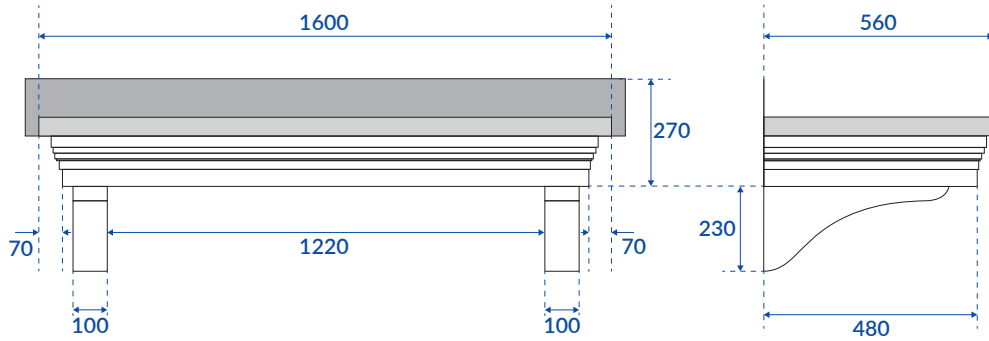

Fixing kit

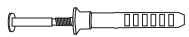

Hammer fixings



Locator bracket



M8 Anchor bolt



Colour coded caps

Please note: The fixing kit supplied contains M8 x 60 - Shield Anchors and 8 x 60mm Nylon Hammer in screws (supplier details on request for additional information) the manufacturer states they are suitable for use in solid brick stone or concrete block. You may require other methods of fixing for your specific site.

Fixing detail

The canopy should be removed from its packaging on receipt and should always be stored on its back with the rear of the upstand facing downwards.

GRP canopies are light in relation to their size and in most cases can be handled manually, care should be taken not to damage the canopy whilst handling/manoeuvring. Please refer to manual handlings REG's 1992 and HSE guidance sheets prior to starting installation of your door canopy.

Installation

Please note: Hammer fixings and anchor bolts must not be set in the mortar line

1. Measure and fix the locator brackets at the required height using the M8 anchor bolts (please see guide below).
2. When fitting the door canopy to the secured locator brackets ensure you push the door canopy down to secure the door canopy to the wall.
3. Check the canopy is sitting level, fix the canopy through the up-stand using hammer fixings at approx 225mm centres*, finish with colour coded caps (please see guide below).
4. Once the canopy is securely fit in position, a bead of all-weather silicone can be run around the top and the sides of the roof upstand to fill any small gaps, avoid sealing the soffit to the wall.

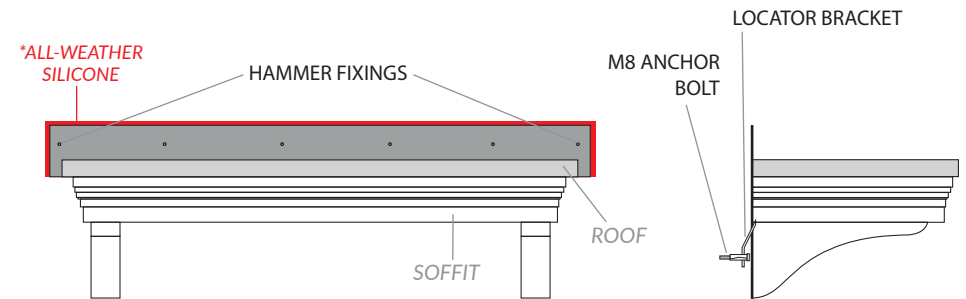

*The fixing points shown are a guide for the hammer fixings.

Hammer fixing & anchor bolt installation guide

1. Drill the correct diameter hole to the correct depth.
2. Clean the hole by brushing and blowing to remove all dust and drilling debris.
3. Insert assembled anchor/fixing through fixture into the concrete.
4. Position fixture and tighten fully, ensuring not to over-tighten.

Royale 1600 & Integral Legs

(not to scale)



ISO 9001
ISO 14001



canopies uk
www.canopiesuk.co.uk